

Article number: 51030567000010

Description: Vibration damper GS-M2
200x60x2000-10, NR shore 57

Measures

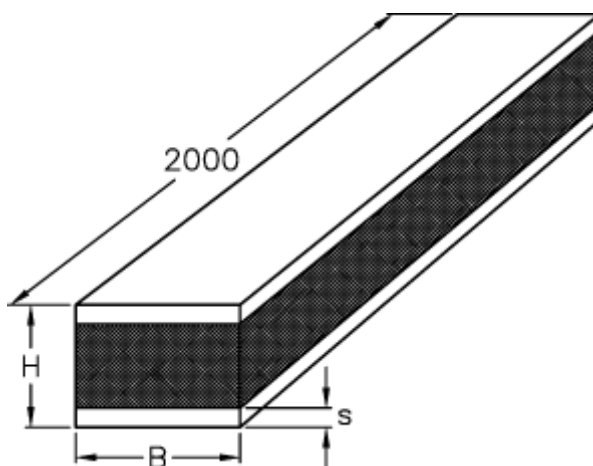

B = 200
H = 60
S = 10